

# xantech

## XDT

### AM/FM STEREO DUAL TUNER

#### OWNER'S MANUAL

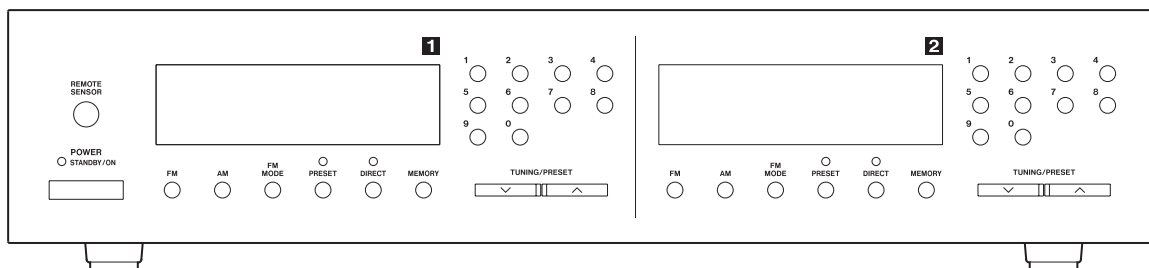

Thank you for choosing XANTECH. Read this manual carefully to get the best performance from this unit.

## Important Safety Instructions



**CAUTION**  
RISK OF ELECTRIC SHOCK  
DO NOT OPEN



CAUTION: TO REDUCE THE RISK OF ELECTRIC SHOCK, DO NOT REMOVE COVER (OR BACK). NO USER-SERVICEABLE PARTS INSIDE. REFER SERVICING TO QUALIFIED SERVICE PERSONNEL.



The lightning flash with arrowhead symbol, within an equilateral triangle, is intended to alert the user to the presence of uninsulated "dangerous voltage" within the product's enclosure that may be of sufficient magnitude to constitute a risk of electric shock to persons.



The exclamation point within an equilateral triangle is intended to alert the user to the presence of important operating and maintenance (servicing) instructions in the literature accompanying the appliance.

**WARNING : TO PREVENT FIRE OR SHOCK HAZARD, DO NOT EXPOSE THIS APPLIANCE TO RAIN OR MOISTURE.**

### For U.S.A.

This equipment has been tested and found to comply with the limits for a Class B digital device, pursuant to Part 15 of the FCC Rules. These limits are designed to provide reasonable protection against harmful interference in a residential installation. This equipment generates, uses, and can radiate radio frequency energy and, if not installed and used in accordance with the instructions, may cause harmful interference to radio communications. However, there is no guarantee that interference will not occur in a particular installation. If this equipment does cause harmful interference to radio or television reception, which can be determined by turning the equipment off and on, the user is encouraged to try to correct the interference by one or more of the following measures:

- Reorient or relocate the equipment and/or the receiving antenna.
- Increase the separation between the equipment and receiver.
- Connect the equipment into an outlet on a circuit different from that to which the receiver is connected.
- Consult the dealer or an experienced radio/TV technician for help.

#### CAUTION

Changes or modifications to this equipments not expressly approved by the manufacturer for compliance will void the user's warranty.

#### CAUTION

- DO NOT REMOVE THE PROTECTIVE HOUSING USING SCREWDRIVER.
- IF THIS PRODUCT DEVELOPS TROUBLE, MAKE A CONTACT WITH OUR SERVICEMAN, AND DO NOT USE THE PRODUCT IN A TROUBLED STATE.

## Important Safety Instructions

- 1) Read these instructions.
- 2) Keep these instructions.
- 3) Heed all warnings.
- 4) Follow all instructions.
- 5) Do not use this apparatus near water.
- 6) Clean only with dry cloth.
- 7) Do not block any ventilation openings. Install in accordance with the manufacturer's instructions.
- 8) Do not install near any heat sources such as radiators, heat registers, stoves, or other apparatus (including amplifiers) that produce heat.
- 9) Do not defeat the safety purpose of the polarized or grounding-type plug. A polarized plug has two blades with one wider than the other. A grounding type plug has two blades and a third grounding prong. The wide blade or the third prong are provided for your safety. If the provided plug does not fit into your outlet, consult an electrician for replacement of the obsolete outlet.
- 10) Protect the power cord from being walked on or pinched particularly at plugs, convenience receptacles, and the point where they exit from the apparatus.
- 11) Only use attachments/accessories specified by the manufacturer.
- 12) Use only with the cart, stand, tripod, bracket, or table specified by the manufacturer, or sold with the apparatus. When a cart is used, use caution when moving the cart/apparatus combination to avoid injury from tip-over.
- 13) Unplug this apparatus during lightning storms or when unused for long periods of time.
- 14) Refer all servicing to qualified service personnel. Servicing is required when the apparatus has been damaged in any way, such as power-supply cord or plug is damaged, liquid has been spilled or objects have fallen into the apparatus, the apparatus has been exposed to rain or moisture, does not operate normally, or has been dropped.



- Do not expose this apparatus to dripps or splashes.
- Do not place any objects filled with liquids, such as vases, on the apparatus.
- Do not install this apparatus in a confined space such as a book case or similar unit.
- The apparatus draws nominal non-operating power from the AC outlet with its POWER switch in the off position.

### For CANADA

#### AC POWER CORD CONNECTION

#### CAUTION:

TO PREVENT ELECTRIC SHOCK, MATCH WIDE BLADE OF PLUG TO WIDE SLOT, FULLY INSERT.

## Contents

Important Safety Instructions .....	2
Contents .....	3
Before Use .....	3
Remote Control Unit .....	3
Connection .....	4
Names of Each Control .....	6
Radio Reception .....	8
Preset Tuning .....	9
Troubleshooting .....	10
Specifications .....	11
AppendixA (RS-232 Commands).....	12

## Before Use

### Read this before operation

- Choose the installation location of your unit carefully. Avoid placing it in direct sunlight or close to a source of heat. Also avoid locations subject to vibrations and excessive dust, heat, cold or moisture.
- Do not open the cabinet as this might result in damage to the circuitry or electrical shock. If a foreign object should get into the set, contact your dealer.
- When removing the power plug from the wall outlet, always pull directly on the plug, never yank the cord.
- Do not attempt to clean the unit with chemical solvents as this might damage the finish. Use a clean, dry cloth.
- Keep this manual in a safe place for future reference.

### Maintenance

If the surface of the unit gets dirty, wipe with a soft cloth or use diluted mild soap liquid. Be sure to remove any excess completely. Do not use thinner, benzine or alcohol as they may damage the surface of the unit.

#### CAUTION

The product shall not be exposed to dripping or splashing and that no object filled with liquids, such as vases, shall be placed on the product.

Do not install this equipment in a confined space such as a book case or similar unit.

## Remote Control Unit

The provided Remote Control Unit allows the unit to be operated from a distance.

When operating the remote control unit, point it towards the REMOTE SENSOR on the front panel of the unit.

- Even if the remote control unit is operated within the effective range, remote control operation may be impossible if there are any obstacles between the unit and the remote control.
- If the remote control unit is operated near other appliances which generate infrared rays, or if other remote control devices using infrared rays are used near the unit, it may operate incorrectly. Conversely, the other appliances may operate incorrectly.

### Battery Installation

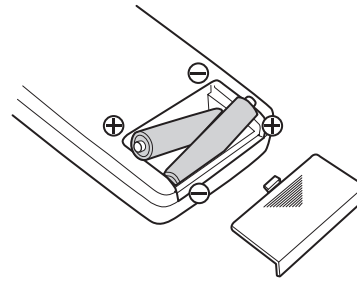

- 1 Remove the battery compartment cover.
- 2 Insert two "AAA" (R03, UM-4) dry batteries. Make sure that the batteries are inserted with their positive "+" and negative "-" poles positioned correctly.
- 3 Close the cover.

### Battery Replacement

If the distance required between the remote control unit and main unit decreases, the batteries are exhausted. In this case replace the batteries with new ones.

### Precautions concerning batteries

- Be sure to insert the batteries with correct positive "+" and negative "-" polarities.
- Use batteries of the same type. Never use different types of batteries together.
- Rechargeable and non-rechargeable batteries can be used. Refer to the precautions on their labels.
- When the remote control unit is not to be used for a long time (more than a month), remove the batteries from the remote control unit to prevent them from leaking. If they leak, wipe away the liquid inside the battery compartment and replace the batteries with new ones.
- Do not heat or disassemble batteries and never dispose of old batteries by throwing them in a fire.

## CAUTION

Turn off the power of all the equipment before making connections.  
Read instructions of each component you intend to use with this unit.

- Be sure to insert each plug securely. To prevent hum and noise, do not bundle the connection cords with the power cord.

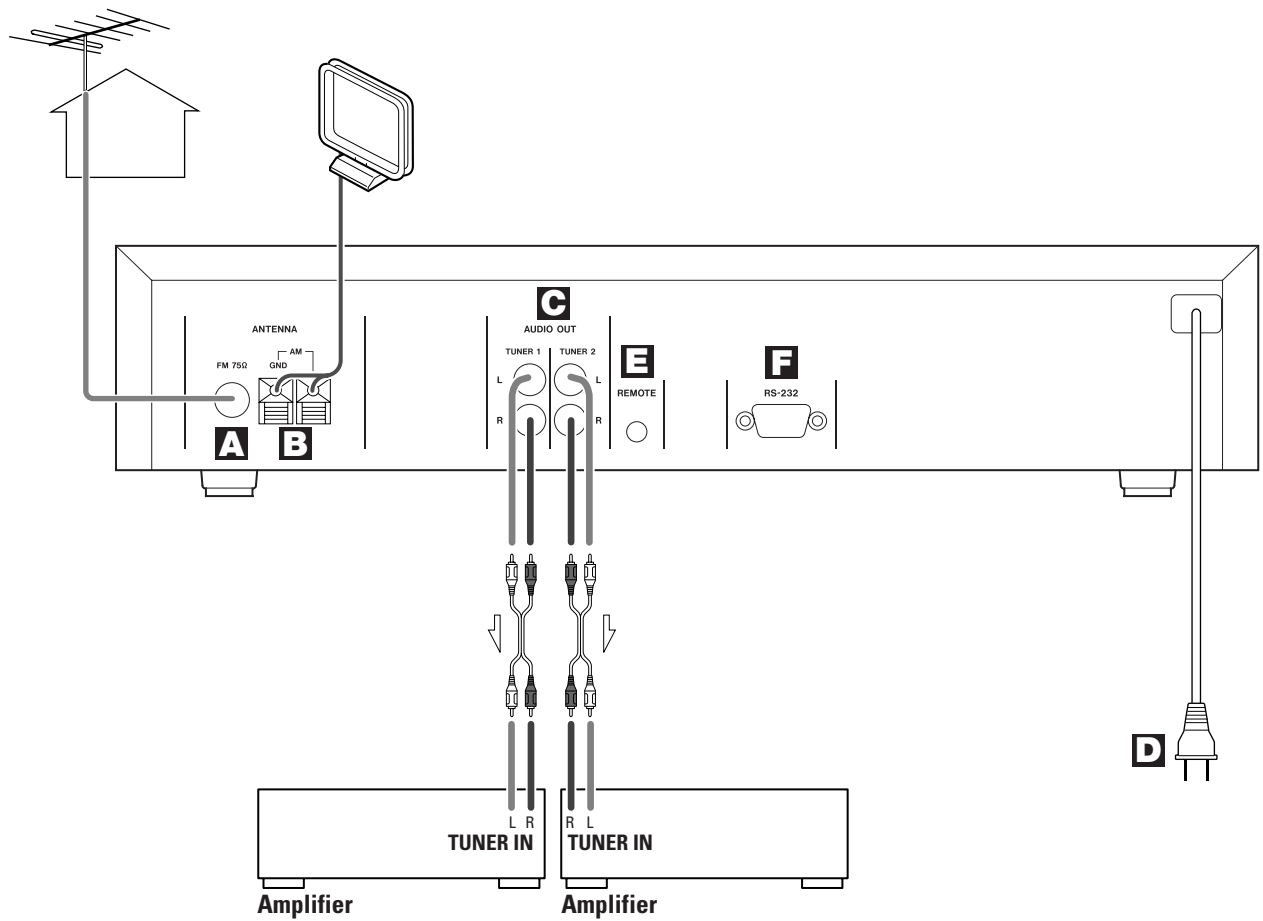

## A FM Antenna

Connect an outdoor FM antenna to the FM 75Ω socket. Generally, a 3-element antenna will be sufficient; if you live in an area where the FM signals are particularly weak, it may be necessary to use one with 5 or more elements.

If standard FM broadcast frequencies are available via your cable service, you may connect your 75 ohm FM antenna jack to your cable system. Please contact your cable service to discuss this option.

## B AM Indoor Loop Antenna

The high-performance AM loop antenna provided with this unit is sufficient for good reception in most areas.

To stand the loop antenna on a surface, fix the claw to the slot.

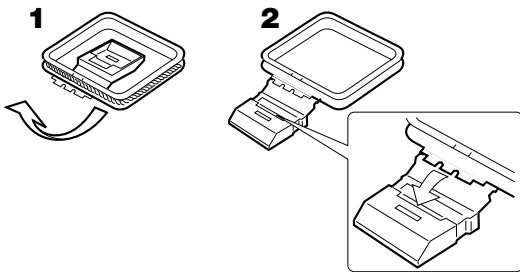

Connect the loop antenna's wires to the AM antenna terminals as shown.

### How to connect

Press the lever, insert the end of the cord, then release the lever. Make sure it is fastened securely by pulling the cord lightly. Make sure only the bare, stripped wire is inserted in the jack and that no plastic insulation is preventing contact between the antenna wire and terminal.

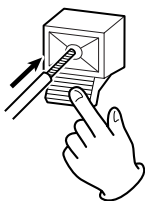

Place the antenna on a shelf, for example, or hang it on a window frame, etc., in the direction which gives the best reception, as far away as possible from the entire system, speaker cords and the power cord, to prevent unwanted noise.

- If the AM loop antenna provided does not deliver sufficient reception (often due to being too far from the transmitter or in a concrete building, etc.), it may be necessary to use an outdoor AM antenna.

Use either a high quality commercial AM antenna or, if not available, an insulated wire more than 15 ft (5 m) long, strip one end, and connect this to the terminal as shown.

The antenna wire should be strung outdoors or indoors near a window. For better reception, connect the GND terminal to a reliable ground.

### Note:

Even when using an outdoor AM antenna, do not disconnect the AM loop antenna.

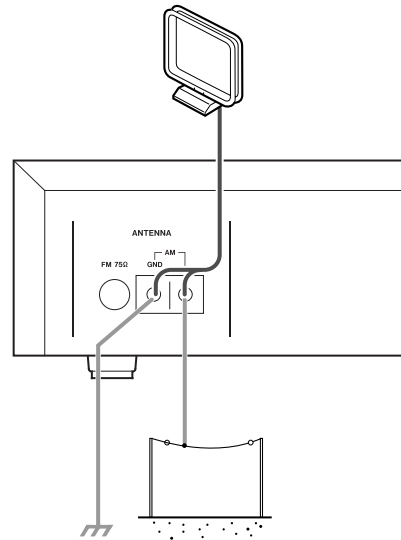

## C AUDIO OUT

Connect the component with RCA pin cords. Make sure to connect:

**white plug → white jack (L:left)**  
**red plug → red jack (R:right)**

## D Power cord (AC)

Be sure to connect the power cord to an AC outlet which supplies the correct voltage.

Hold the power plug when plugging or unplugging the power cord.

## E REMOTE

Used for a wired remote control unit (optional).

## F RS-232

Used for a wired RS-232 standard remote control unit (optional).

# Names of Each Control

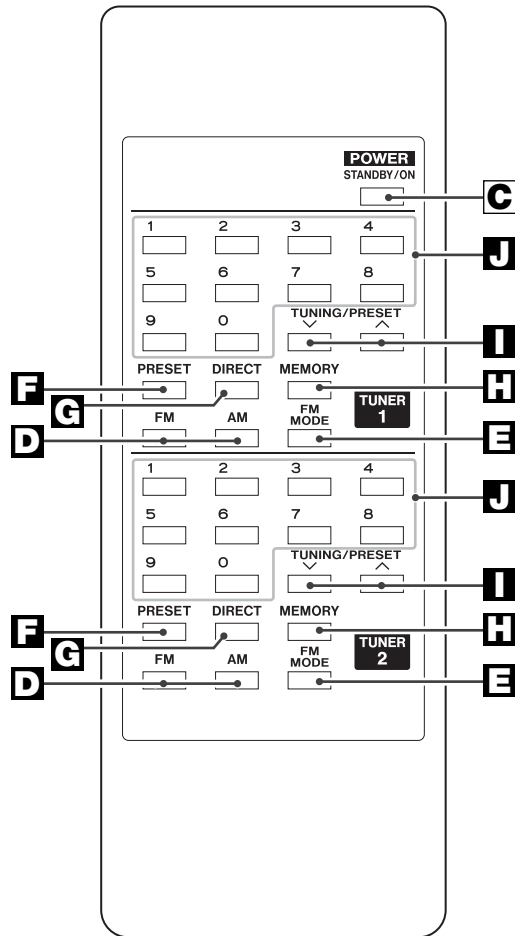
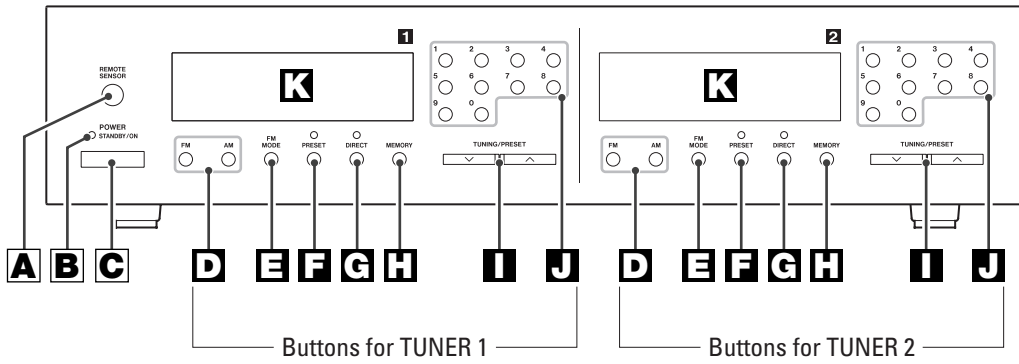

**A REMOTE SENSOR**

When operating the remote control unit, point it towards the REMOTE SENSOR.

**B STANDBY indicator**

This indicator lights when the unit is in the standby mode.  
When the unit is turned on, it goes off.

**C POWER switch**

Press this switch to turn the unit on or off.

The equipment draws nominal non-operating power from the AC outlet with its POWER switch in the OFF position.

**D FM button, AM button**

Use these buttons to select FM or AM.

**E FM MODE button**

Use this button to select stereo or monaural.

**F PRESET button**

Use this button to select the preset tuning mode.

**G DIRECT button**

Use this button to select the manual tuning mode.  
You can use the numeric buttons to directly input frequency numbers.

**H MEMORY button**

Use this button to store preset channels into memory.

**I TUNING/PRESET buttons**

Use these buttons to tune in a station.

**J Numeric buttons**

These buttons are used either to input frequency numbers or to select preset stations.

**K Display**

**Note:**

To simplify explanations, instructions refer to names of buttons and controls on the front panel, making no mention of the use of remote control unit.

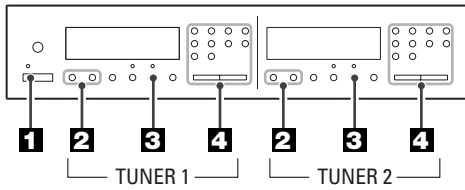

**1** Press the **POWER** switch to turn the unit on.

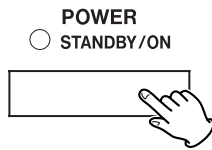

**2** Select the **AM** or the **FM** band by pressing the corresponding button.



**3** Press the **DIRECT** button to select the manual tuning mode.



**4** Select the station you want to listen to.

- "TUNED" is displayed when a broadcast is correctly tuned in.

**A** Auto Selection

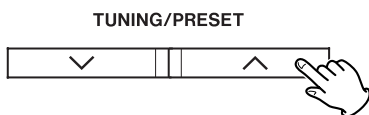

Hold down the TUNING/PRESET button for 0.5 to 2 seconds. When a station is tuned in, the tuning process will stop automatically.

If you want to stop the tuning process, press the TUNING/PRESET button.

**B** Manual Selection  
(Selecting stations which cannot be tuned automatically)

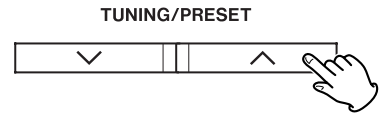

When the TUNING/PRESET button is pressed momentarily (0.5 second or less), the frequency changes by a fixed step.

**FM : 0.2 MHz steps**  
**AM : 10 kHz steps**

Press the TUNING/PRESET button repeatedly until the station you want to listen to is found.

**C** Direct Tuning

Input the frequency numbers with the numeric buttons.

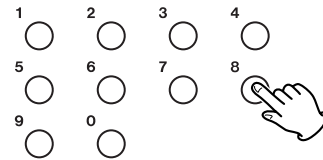

**Example**

To select FM 88.30 MHz : 8→8→3

To select AM 1220 kHz : 1→2→2→0

- When no button is pressed for 3 seconds, the mode will be cancelled.

## FM MODE Button

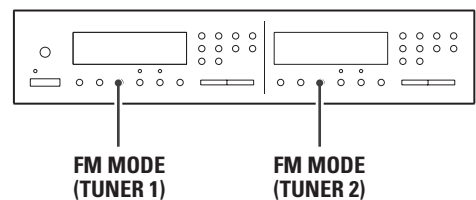

Pressing this button alternates between Stereo mode and Mono mode.

**Stereo**

FM stereo broadcasts are received in stereo and the "STEREO" indicator lights in the display.

**Mono**

To compensate for weak FM stereo reception, select this mode. Reception will now be forced monaural, reducing unwanted noise.

# Preset Tuning 1

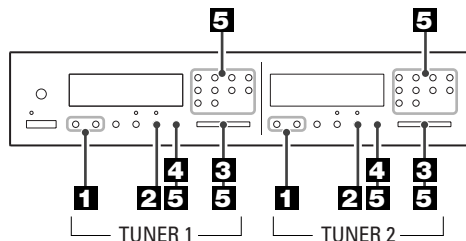

## Manual Memory Presetting

You can store your favorite FM and AM stations into any of the 30 preset locations by:

**1** Select the AM or FM band by pressing the corresponding band button.

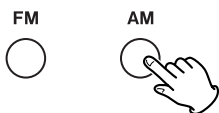

**2** Press the DIRECT button to select the "manual tuning" mode.



**3** Select the station you would like to store by scrolling through the station using the TUNING/PRESET buttons or directly tune the station by using the numeric buttons.

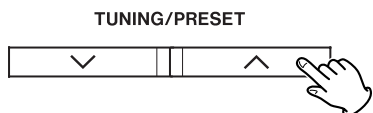

**4** Once the station is tuned, press the MEMORY button.



**5** While the MEMORY indication is flashing select the preset you would like to use for this station by EITHER:

Scroll up or down using the TUNING/PRESET buttons until the preset is displayed. Then press the MEMORY button to store

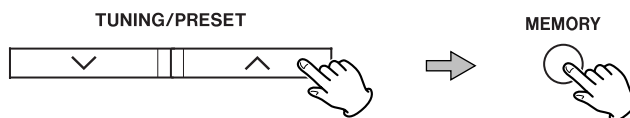

OR enter the 2-digit preset number using the numeric pad. (For instance "05" will store the station in preset number 5. "25" will store the station in preset location 25.) The preset will automatically be stored and the memory indication will stop flashing.

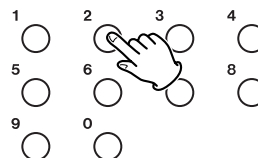

To store more stations, repeat steps **3** through **5**.

## Preset Tuning 2

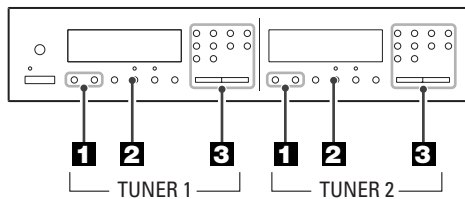

### How to select preset stations

- 1 Select the AM or the FM band by pressing the corresponding button.



- 2 Press the PRESET button.



- 3 Select a preset channel using the numeric buttons.

Or press the TUNING/PRESET button repeatedly until the desired preset station is found.

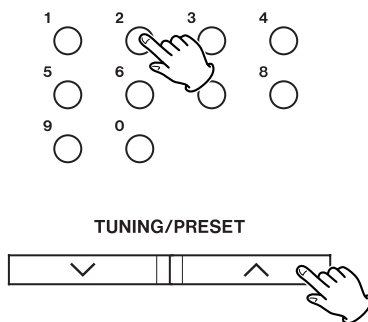

### Memory Backup

Settings are stored permanently, even when power is turned off and the unit is unplugged.

## Troubleshooting

If you experience any problems with the unit, please take a moment to look through this chart and see if you can solve the problem yourself before you call your dealer or service center.

### No power

- ➔ Check the connection to the AC power supply. Check and make sure the AC source is not a switched outlet and that, if it is, the switch is turned on. Make sure there is power to the AC outlet by plugging another item such as a lamp or fan.

### Cannot listen to any station, or signal is too weak.

- ➔ Make sure the antenna is properly connected.
- ➔ Tune in the station properly.
- ➔ If a TV is near the unit, turn it off.
- ➔ Install the antenna again after relocating it to a better reception position.
- ➔ An external antenna may be required.

### Though the broadcast is stereo, it sounds monaural.

- ➔ Press the FM MODE button.

### Remote control doesn't work.

- ➔ Press the POWER switch to turn the unit on.
- ➔ If the batteries are dead, change the batteries.
- ➔ Use remote control unit within the range (5m /15ft) and point at the front panel.
- ➔ Clear obstacles between the remote control unit and the main unit.
- ➔ If a strong light is near the unit, turn it off.

**If normal operation cannot be recovered, unplug the power cord from the outlet and plug it again.**

# Specifications

## FM Tuner Section (Without notes 98.1 MHz, 65 dBf)

Tuning Range . . . . . 87.5 MHz – 107.9 MHz (200 kHz steps)  
Usable Sensitivity (IHF) . . . . . Mono: 15 dBf  
50 dB Quieting Sensitivity . . . . . Mono: 21 dBf, Stereo: 41 dBf  
Total Harmonic Distortion (1 kHz) . . . . . Mono: 0.3%, Stereo: 0.4%  
Frequency Response . . . . . 30 Hz – 15 kHz,  $\pm 1.5$  dB  
Stereo Separation (1 kHz) . . . . . 40 dB  
Signal-to-Noise Ratio . . . . . Mono: 67 dB, Stereo: 63 dB

## AM Tuner Section

Tuning Range . . . . . 530 kHz – 1,710 kHz (10 kHz steps)  
Usable Sensitivity . . . . . 64 dB/m  
Total Harmonic Distortion . . . . . 1% at 85 dB/m  
Signal-to-Noise Ratio . . . . . 40 dB at 85 dB/m

## General

Power requirements . . . . . 120 V AC, 60 Hz  
Power Consumption . . . . . 12 W  
Dimensions (W x H x D) . . . . . 435 x 95 x 270 mm  
(17-1/8" x 3-3/4" x 10-5/8")  
Weight (net) . . . . . 4 kg (8-13/16 lbs)  
Standard Accessories . . . . . Remote Control Unit x 1  
Battery (AAA, R03, UM-4) x 2  
AM Loop Antenna x 1  
FM adapter x 1  
RCA Cord x 2

- Improvements may result in specifications and features changing without notice.
- Illustrations may differ slightly from production models.

Appendix A

# XDT DUAL AM/FM TUNER

## RS-232 COMMANDS

**PURPOSE:**

This document describes the RS-232 commands that will operate the XANTECH XDT Dual Tuner through the 9-pin RS-232 connector on the rear panel.

**General Information:**

**Data Rate:** 19,200 baud  
**Parity:** None  
**Word length:** 8 data bits, 1 stop bit  
**Handshake:** No RTS/CTS handshaking  
**Connections:** simple 3 wire (Rx, Tx, Gnd) interface

**RS-232 Pin Assignment & Protocol Specification:**

Connector: Female DB9  
 Pin 3: Rx Data  
 Pin 2: Tx Data  
 Pin 5: Ground  
 Data Transmission Speed: 19,200 bps  
 Command Spacing: >25msec  
 Character Length: 8 bit  
 Parity Bit: None  
 Stop Bit: 1 bit  
 Transfer Bit: LSBit Fast

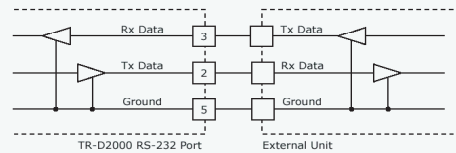

**DATA ENTRY PROTOCOL:**

The serial buss should follow a standard serial communications protocol using Line oriented ASCII data stream. The command line must be followed with a carriage return for the unit to respond. The unit should not echo characters received back to the host.

**Command Codes:**

Character	Range	Function	Example
<b>X:</b>	0,1	Power Off / On	X1 = Power On, X0 = Power Off
<b>T:</b>	1,2	Tuner #	T1 = Tuner 1, T2 = Tuner 2
<b>B:</b>	1,2	Band #	B1 = AM, Band 2 = FM
<b>P:</b>	00 - 30	Preset #	P01 = Preset 1, P30 = Preset 30, P00 (just for status) = No Preset Selected
<b>F:</b>	4 numbers	Frequency Setting	F0890 = 890 AM, F1045 = 104.5 FM
<b>A:</b>	0,1	Seek Up / Down	A0 = Seek Down, A1 = Seek Up
<b>M:</b>	0,1	Step Up / Down	M0 = Step Down 1 step, M1 = Step Up 1 step
<b>S:</b>	Signal Lock / Stereo Presence	1 = locked, 0 = not 1 = stereo, 0 = mono	S00 (just for status) = no signal, no stereo, S01 = invalid S10 = signal lock (mono), S11 = signal lock (stereo)
<b>Q:</b>	Query status of tuner	ask for tuner status	Q1 = Status of Tuner 1, Q2 = Status of Tuner 2 Q3 = Status of both tuners, 1 then 2
<b>N:</b>	0,1	Preset Step Up / Down	N0 = Step Down 1 Preset, N1 = Step Up 1 Preset
<b>L:</b>	01 - 30	Set Preset	L01 = Set Station as Preset #1

**Command Examples:**

**T1B2P01<cr>** would command tuner #1 to select band 2 (FM) and tune to FM preset #1  
**T2B1F1070L03<cr>** would command tuner #2 to set AM frequency 1070 kHz as AM preset #3  
 This command however, would not change the current station tuned on Tuner #2  
**To select a station to be tuned and THEN set that station as a preset, would require two commands:**  
**T2B1F1070<cr>** would command tuner #2 to select band 1 (AM) and tune to frequency 1070 kHz.  
**T2L03<cr>** would command tuner 2 to set the currently tuned station (in this example AM 1070) as AM preset #3

**Query Example:**

**Q1<cr>** would solicit the following response:  
 Feedback as to the status of tuner #1, which would include band select, station preset, frequency tuned, signal lock and stereo presence. The response string would look like this:**T1B2P00F1011S11**  
**T1** (tuner 1) **B2** (FM), **P00** (no preset selected), **F1011** (frequency 101.1 MHz), **S11** (signal lock & stereo)

**Shortcut Commands:**

*Note: examples below are assuming Tuner 1 is in FM stereo mode and tuned to a station*

Command	Response/Action
<b>T1N1&lt;cr&gt;</b>	Tuner 1 would step up to the next higher preset number
<b>T1L01&lt;cr&gt;</b>	Tuner 1 would set the currently tuned station as FM preset #1
<b>T1S10&lt;cr&gt;</b>	Tuner 1 would switch the FM mode to mono
<b>T1M1&lt;cr&gt;</b>	Tuner 1 would step up the frequency 0.2 MHz
<b>T1A0&lt;cr&gt;</b>	Tuner 1 would go into "seek down" mode
<b>T1B1&lt;cr&gt;</b>	Tuner 1 would go to AM mode and tune to the last previously tuned AM station

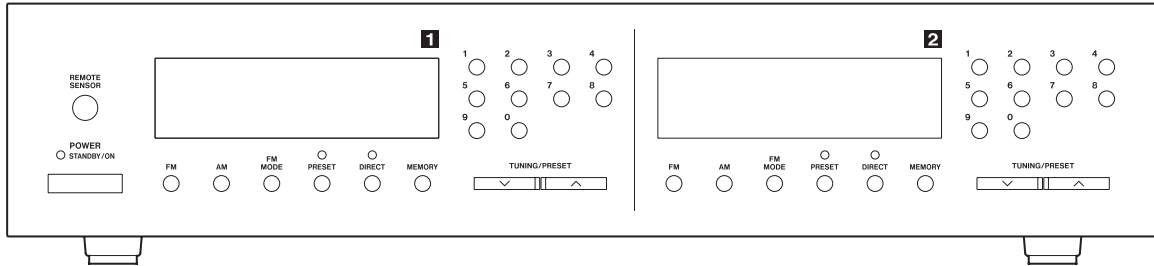

### AM/FM STEREO DUAL TUNER

This appliance has a serial number located on the rear panel. Please record the model number and serial number and retain them for your records

Model number: \_\_\_\_\_

Serial number: \_\_\_\_\_

# xantech

## XDT

Xantech Corporation 13100 Telfair Avenue, Second Floor Sylmar, CA 91342-3573 Sales: 800.843.5465 • Fax: 818.362.9506  
Thank you for choosing XANTECH. Read this manual carefully to get the best performance from this unit.